

ASSEMBLY INSTRUCTION

80509/10

CHAIRSIDE TABLE

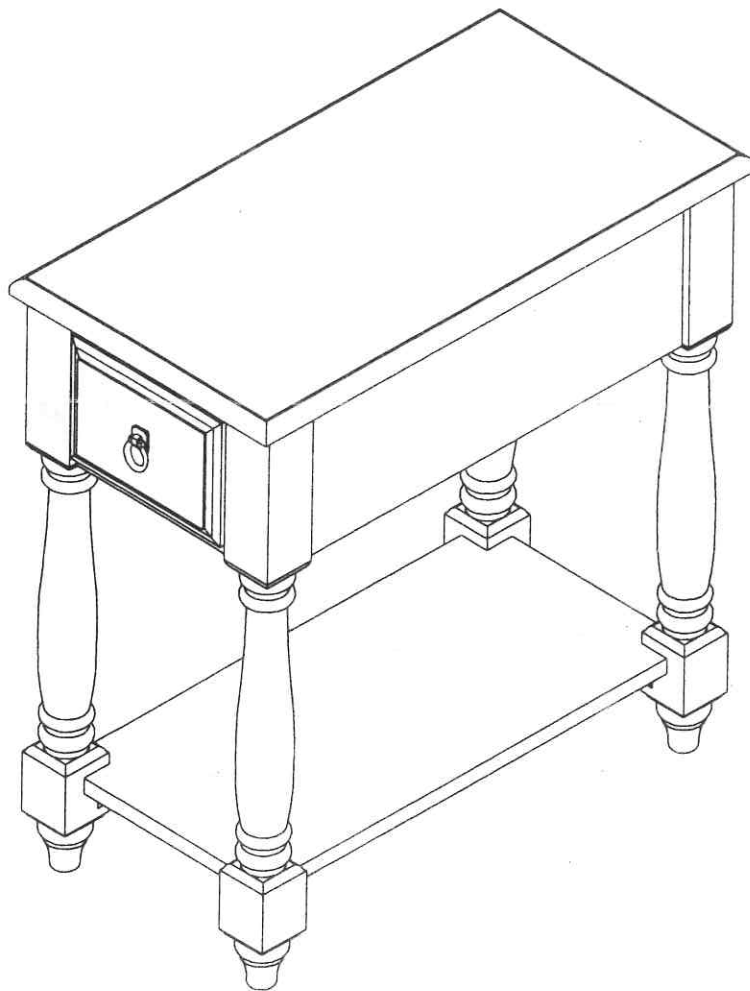

ASSEMBLY INSTRUCTION







ASSEMBLY TIPS :

- 1 . Remove hardware from box and sort by size .
- 2 . Please check to see that all hardware and parts are present prior start of assembly .
- 3 . Please follow attached instructions in the same sequense as numbered to assure fast & easy assembly .

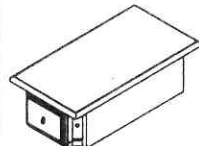

Warning !

- 1 . Don't attempt to repair or modify parts that are broken or defective . Please contact the store immediately .
- 2 . This product is for home use only and not intended for commercial establishment .

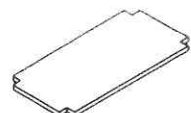
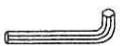
PARTS LIST				HARDWARES REQUIRED			
1	41x18x2mm		4PCS	A	CHAIR BACK		1PCS
2	Ø1/4"x50mm		8PCS				
3	Ø 1/4"x15mm		8PCS				
4	Ø 1/4' x16mm		8PCS	B			4PCS
5	Ø1/4" x 10.5mm		16PCS				
6	Ø 1/4" x 12mm		8PCS	C			1PC
7	M4 x 57mm		1PC				

STEP 1

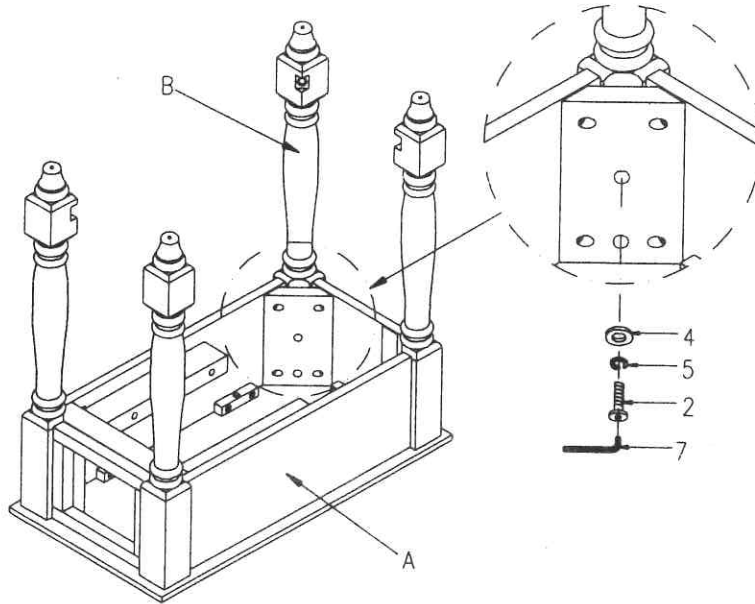

STEP 2

