

ASSEMBLY INSTRUCTION







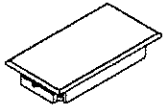

ASSEMBLY TIPS :

- 1 . Remove hardware from box and sort by size .
- 2 . Please check to see that all hardware and parts are present prior start of assembly .
- 3 . Please follow attached instructions in the same sequense as numbered to assure fast & easy assembly .

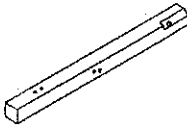

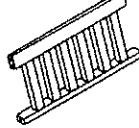
Warning !

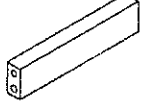
- 1 . Don't attempt to repair or modify parts that are broken or defective . Please contact the store immediately .
- 2 . This product is for home use only and not intended for commercial establishment .

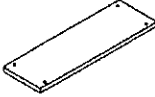
PARTS LIST				HARDWARES REQUIRED			
1	Ø 1/4"X60mm		8PCS	A	TABLE TOP		1PCS
2	Ø 1/4"X50mm		4PCS				
3	Ø 1/4"X25mm		4PCS	B	LEGS		4PCS
4	Ø1/4"x13mm		8PCS				
5	Ø 1/4"X10.5mm		16PCS	C	MAGAZINE RACK		2PCS
6	Ø 1/4"X12mm		12PCS				
7	Ø 1/4"X16mm		4PCS	D	STRETCHER		2PCS
8	M4		1PC				
9	Ø 13.5mmX8mm		8PCS	E	SHELF		1PC

STEP 1

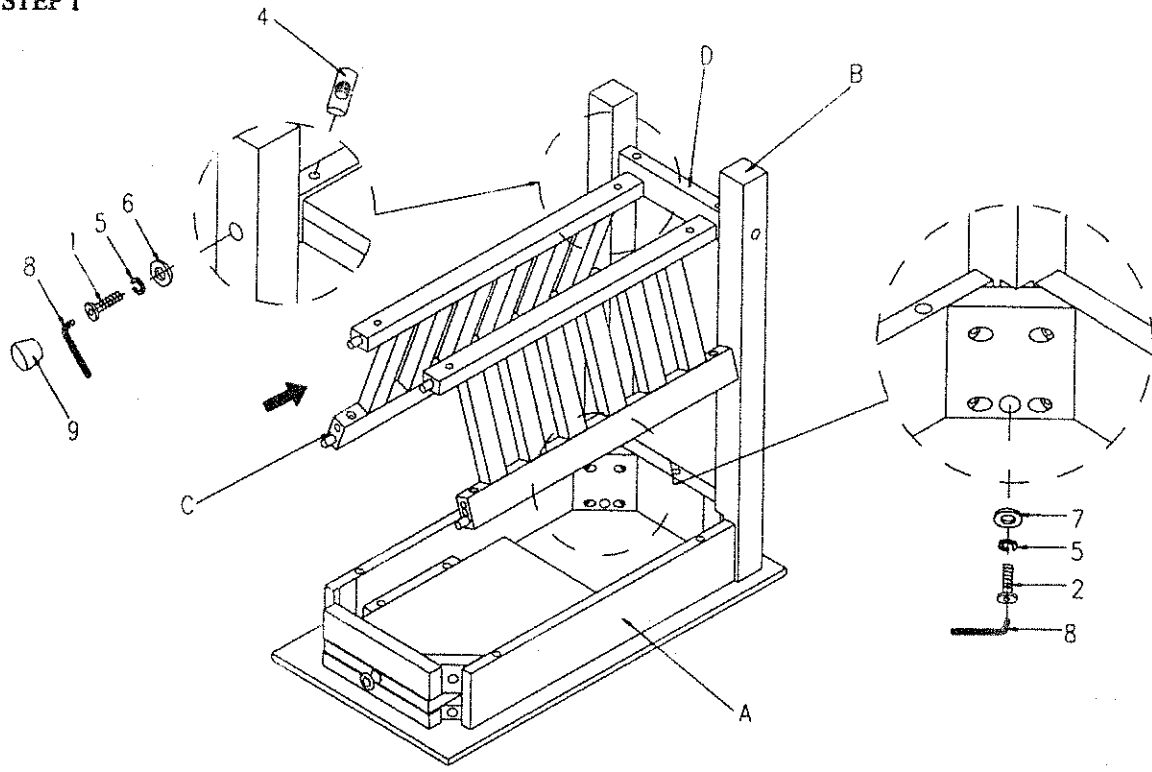

STEP 2

