

# ASSEMBLY INSTRUCTION FOR ACME FURNITURE

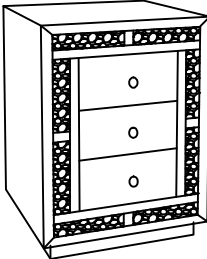



## MODEL#97653

Thank you for purchasing the quality product. Be sure to check all packing material carefully for small parts which may have come loose inside the carton during shipment. Separate, identify and count all parts and metal hardware. Compare with all parts list to be sure all parts are present. If any part(s) are missing or damaged, please contact your local furniture dealer. For efficient and speedy service, please indicate the model number and code letter of part(s) needed.

\*\*\* Do not fully tighten screws until fully assembled \*\*\*

COMPONENT PARTS		
DESCRIPTION	PART NAME	Q'TY (PCS)
①	LOCKERS  	1

## HARDWARE REQUIRED

(A)		BOLT	3 PCS
(B)		METAL WASHER	3 PCS
(C)		SILICON WASHER	3 PCS
(D)		KNOB	3 PCS
(E)		SCREWDRIVER	1 PC

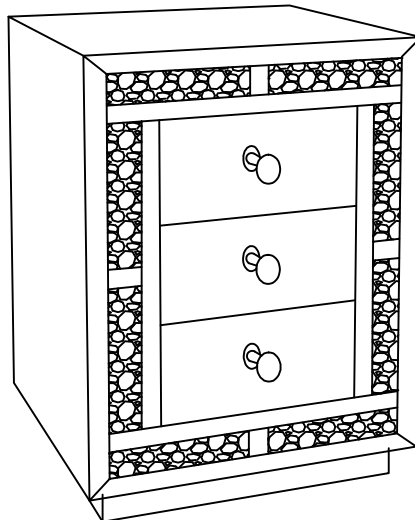

### Attention

\*\*\* Some number parts listed on the instruction sheet may not be in parts bag as they may already be assembled. Carefully check parts and packing materials prior to ordering replacements.

## How to assemble:

### STEP 1

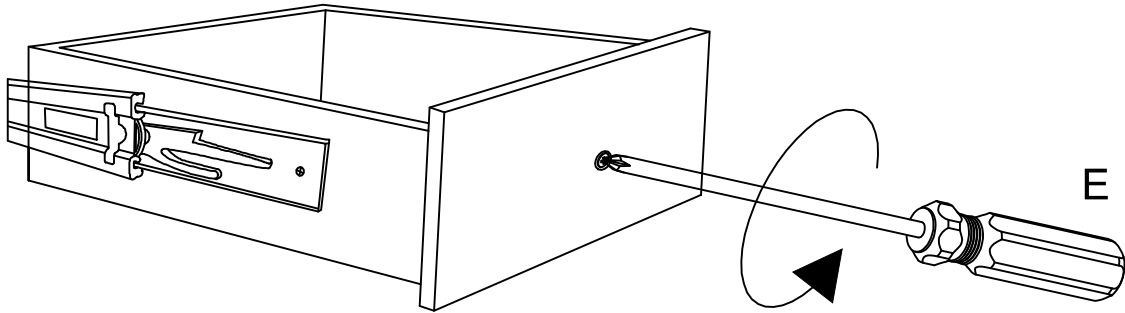

Open the drawer and remove the handle and accessories with a screwdriver.

### STEP 2

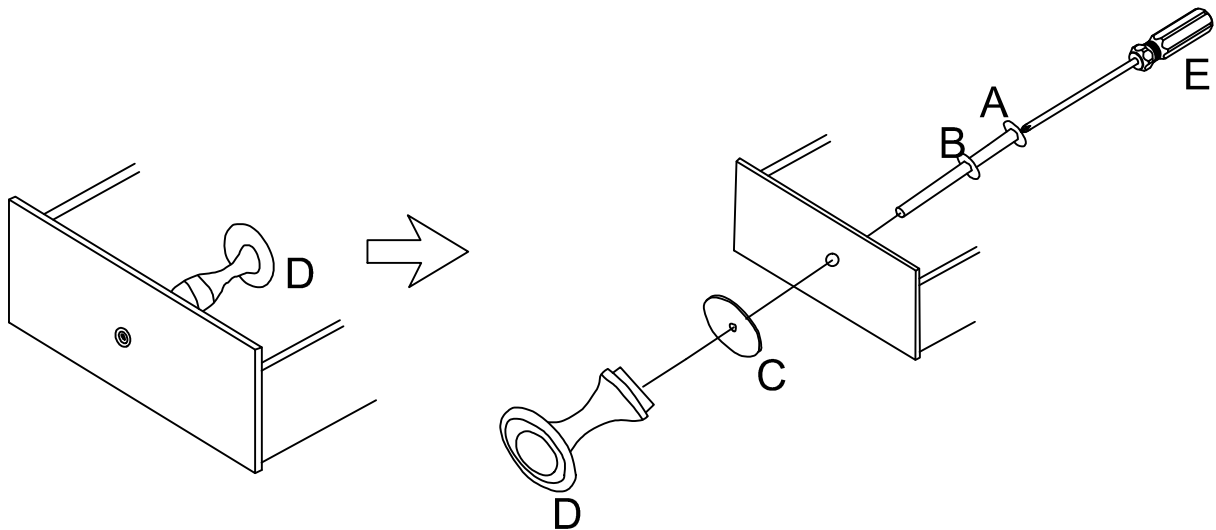

Place the accessories in the order shown above. Use a screwdriver to secure the handle to the outside of the drawer.

## How to assemble:

### STEP 3

# Anti-tipping Restraint Instructions

#### HARDWARE

- \* 1 metal strap(A)
- \* 2 hoop(B)
- \* 1 pull ring (C)
- \* 1 wall brackets(D)
- \* 2 screw(E)
- \* 2 wall plugs

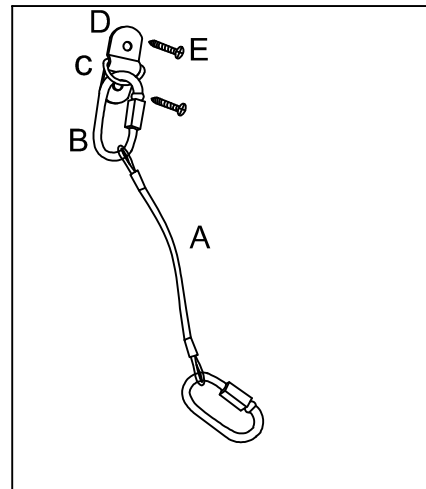

#### Important note:

- \* Pre fixed wall straps have been provided for your safety and we recommend that once in position the unit is secured using these.
- \* When drilling into walls, always check there are no hidden wires or pipes etc'
- \* Put pull ring(C) into wall bracket(D).
- \* Position the bracket on your wall and mark the holes to be drilled. We recommend the bracket is fitted just below the top of your unit so that it is not visible when the unit is in place.
- \* Attach bracket (D), with pull ring (C) in place, using screws and wall plugs
- \* Attach the strap (A) to the back of the unit using hoop (B). Ensure the hoop (B) is locked.
- \* Carefully lift the unit into place and attach the free end of strap (A) to pull ring (C) on the wall,using hoop (B) and lock it.
- \* Check to make sure all parts are secure and carefully move unit into position.

