

ASSEMBLY INSTRUCTION FOR ACME FURNITURE

MODEL# 52645 SOF 52646 CHA 52650 SOF 52651 CHA

Thank you for purchasing tue quality product. Be sure to check all packing material carefully for small parts which may have come loose inside the carton during shipment. Seperate, identify and count all parts and metal hardware. Compare with all parts list to be sure all parts are present. if any part(s) are missing or damaged, please contact your local fumiture dealer .For efficient and speedy service,please indicate the model number and code letter of part(s) needed.

BOX-1

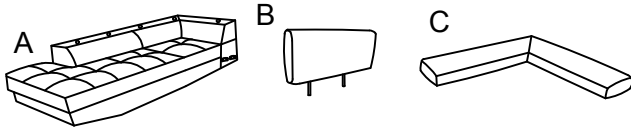

BOX-2

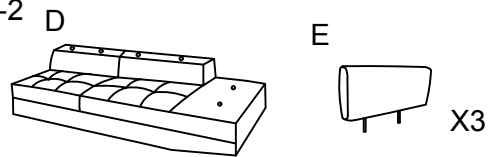

DO not fully tighten screws until fully assembled

HARDWARE REQUIRED

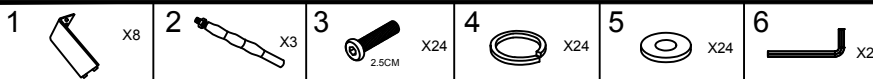

STEP-1

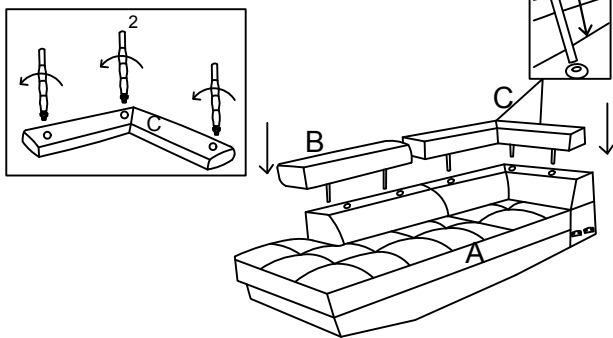

STEP-2

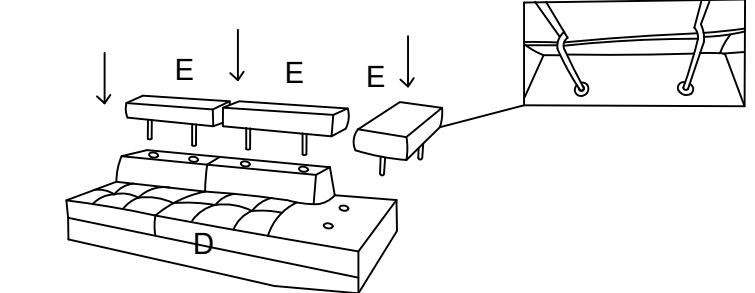

STEP-3

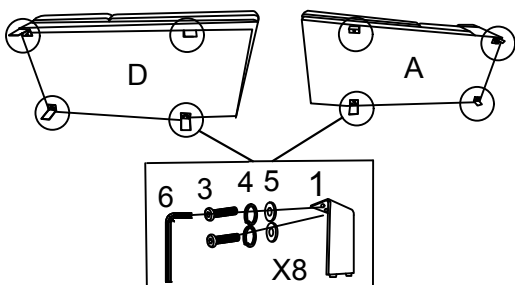

STEP-4

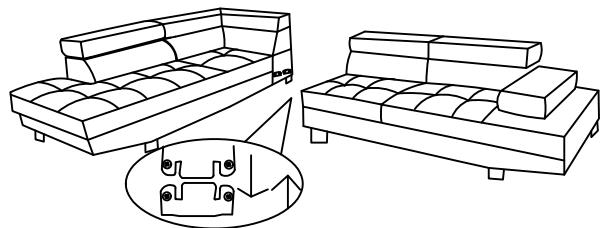

STEP-5

