







ASSEMBLY INSTRUCTION FOR ACME FURNITURE

MODEL #55440

Thank you for purchasing the quality product. Be sure to check all packing material carefully for small parts which may have come loose inside the carton during shipment. Separate, identify and count all parts and metal hardware. Compare with all parts list to be sure all parts are present. If any part(s) are missing or damaged, please contact your local furniture dealer. For efficient and speedy service, please indicate the model number and code letter of part(s) needed.

COMPONENT PARTS			
DESCRIPTION	PART NAME		Q'TY (PCS)
①	LEFT EAR		1
②	RIGHT EAR		1
③	LEFT BACK CUSHION		1
④	MIDDLE BACK CUSHION		1
⑤	RIGHT BACK CUSHION		1
⑥	ASSEMBLED SEAT/ARM FRAME		1

Attention:

*** Some number parts listed on the instruction sheet may not be in parts bag as they may already be assembled. Carefully check parts and packing materials prior to ordering replacements.

Fragile Spots :

***Be careful , do not grip at fragile spots where they can be damaged easily .

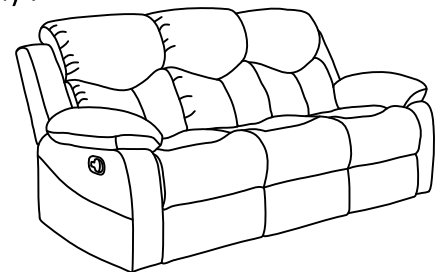
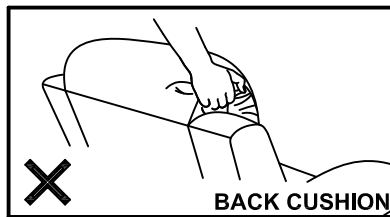
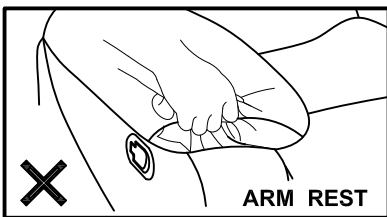

How to assemble:

STEP 1: Note : Match both side metal bracket , push down back cushion to assemble .

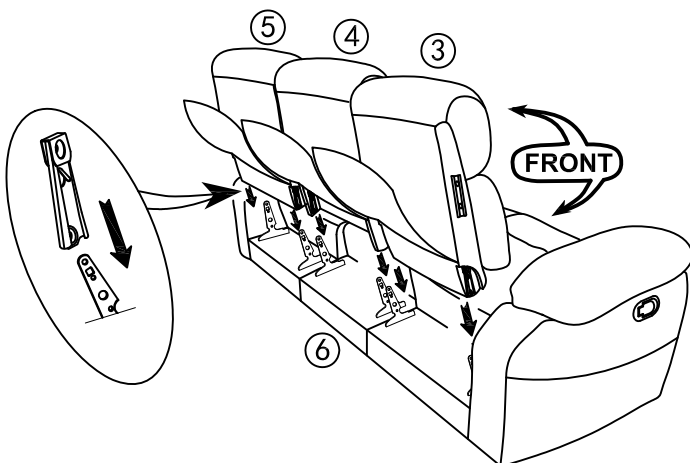

STEP 2:

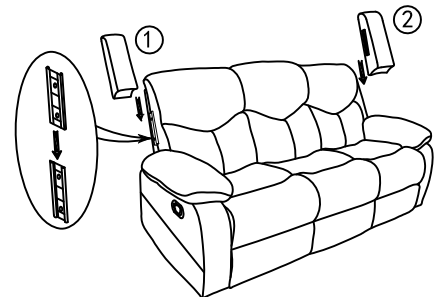

STEP 3:

