

# ASSEMBLY INSTRUCTION FOR ACME FURNITURE

## MODEL# OF00013/OF00014

Thank you for purchasing the quality product. Be sure to check all packing material carefully for small parts which may have come loose inside the carton during shipment. Separate, identify and count all parts and metal hardware. Compare with all parts list to be sure all parts are present. If any part(s) are missing or damaged, please contact your local furniture dealer. For efficient and speedy service, please indicate the model number and code letter of part(s) needed.

**\*\*\*Do not fully tighten screws until fully assembled\*\*\***

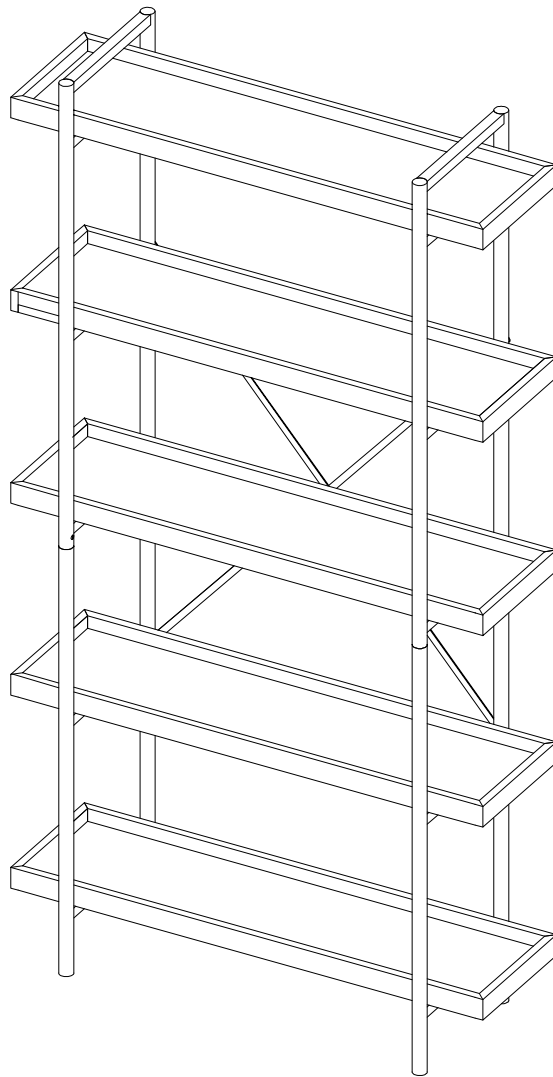

### Attention:

**\*\*\*Some number parts listed on the instruction sheet may not be in parts bag as they may already be assembled. Carefully check parts and packing materials prior to ordering replacements.**

# General Assembly Guidelines



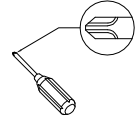
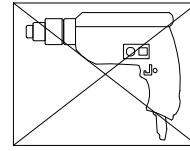



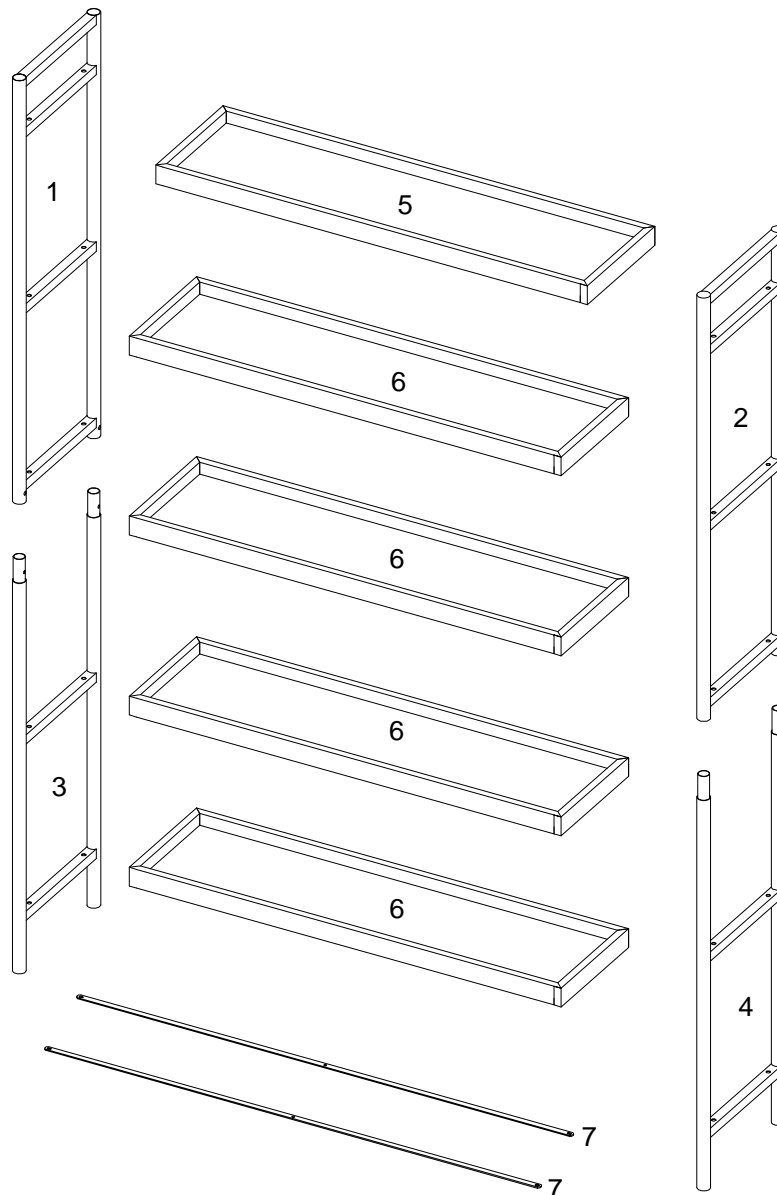

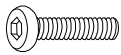

- I. Ensure that all parts and hardware are available before beginning assembly.
- II. Follow each step carefully to ensure the proper assembly of this product.
- III. Two people are recommended for ease in the assembly of this product.
- IV. The main type of hardware used to assemble this product are: bolts and screws.
- V. Power tools should not be used to assemble this product.
- VI. A Phillips head screwdriver is required for the assembly of this product.
- VII. Drill may be needed for securing product to wall.





## Parts List

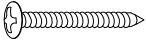

## Hardware List



A		Ø1/4"*30mm	Bolt	20 pcs
B		Ø1/4"*12mm	Bolt	5 pcs
C		Ø4*12mm	Screw	4 pcs
D		M4*10mm	Bolt	1 pc
E		M4mm	Nut	1 pc
F			L shape bracket	1 pc
G			Wrench	1 pc
H		M4mm	Wrench	1 pc
I			Wall anchor	1 pc
J		Ø4*30mm	Screw	1 pc
K		Ø16*6.5*1.0mm	Washer	1 pc

# Step 1

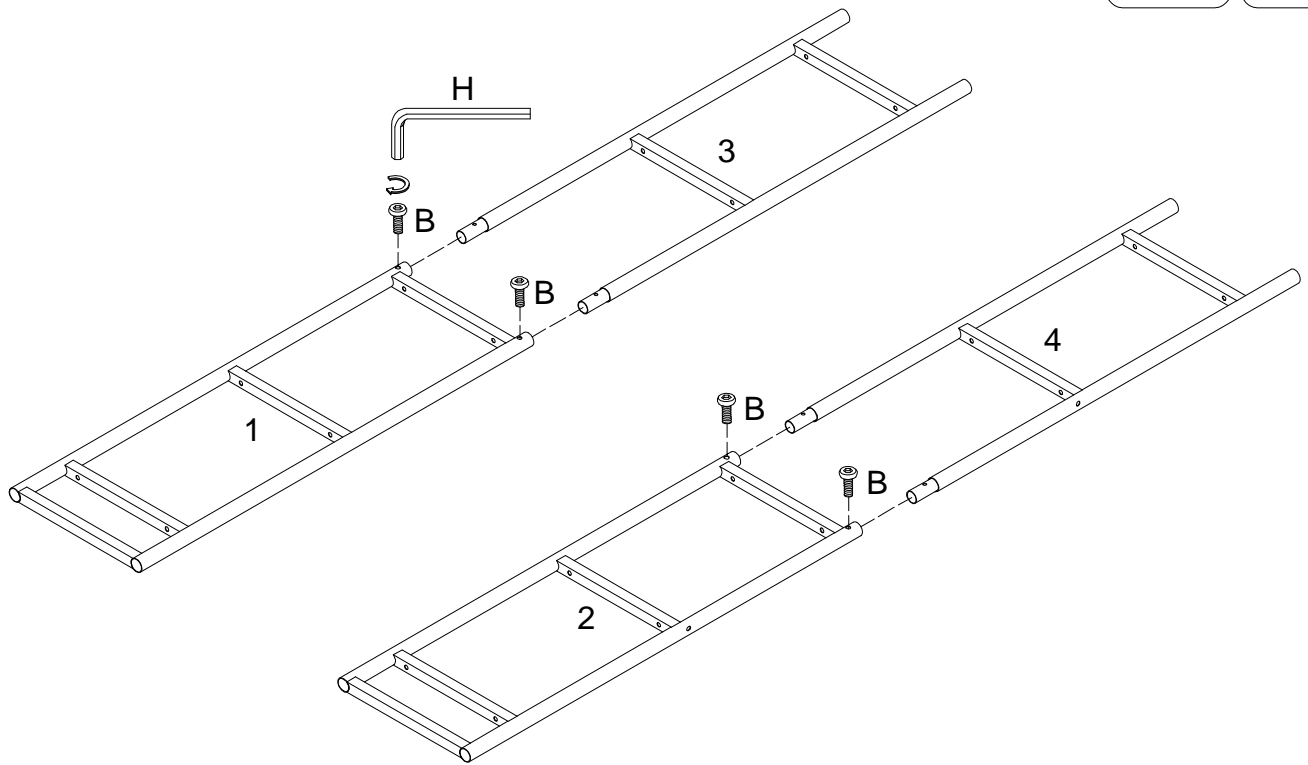
<b>B x 4</b>	<b>H x 1</b>
	
Ø1/4**12mm	M4mm



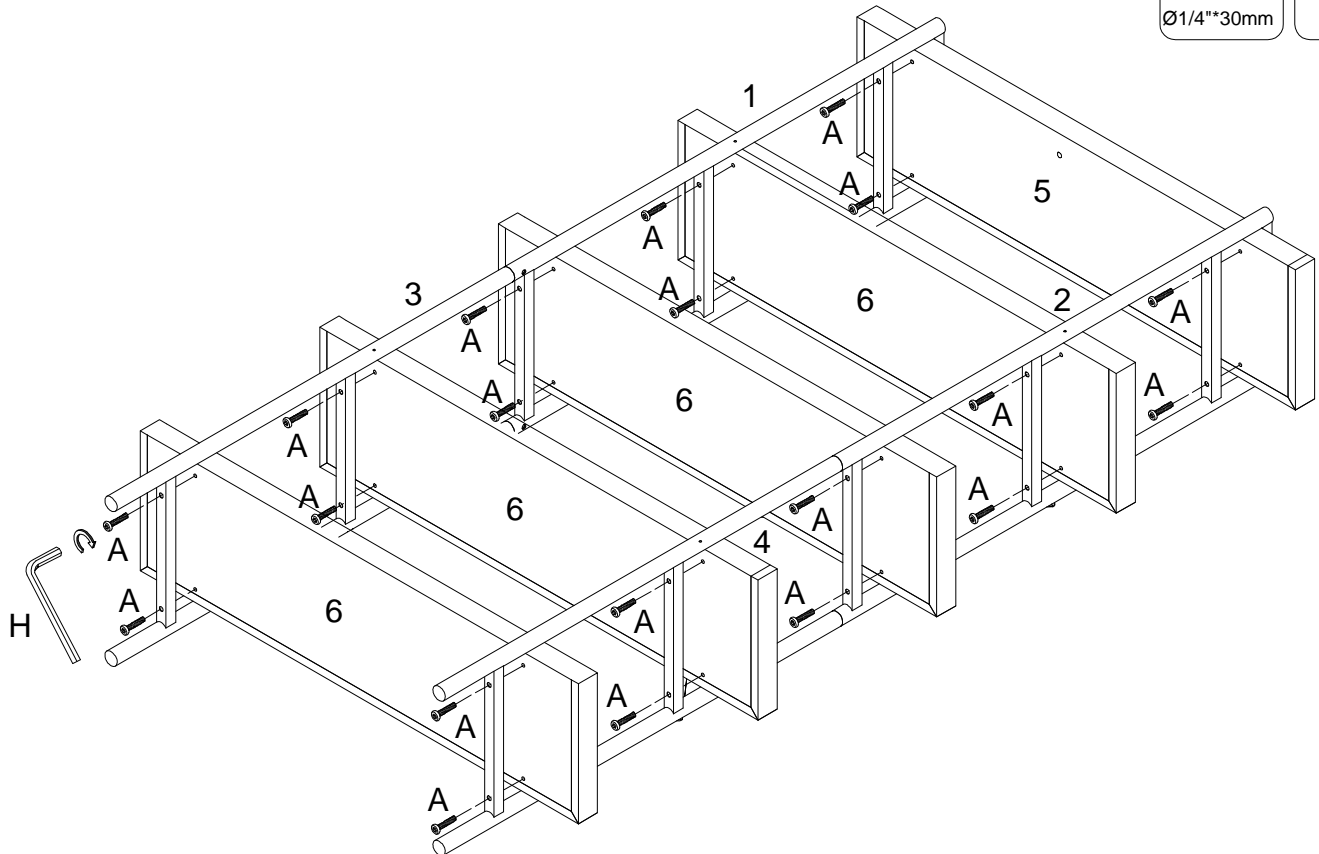

# Step 2

<b>A x 20</b>	<b>H x 1</b>
	
Ø1/4**30mm	M4mm



# Step 3

D x 1  
  
M4\*10mm

E x 1  
  
M4mm

G x 1  

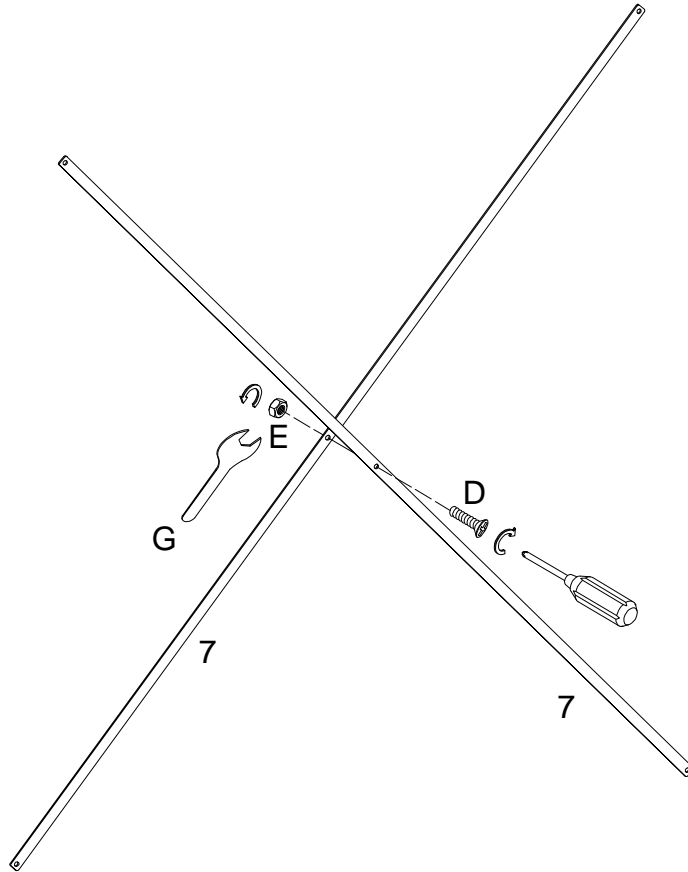

# Step 4

C x 4  
  
Ø4\*12mm

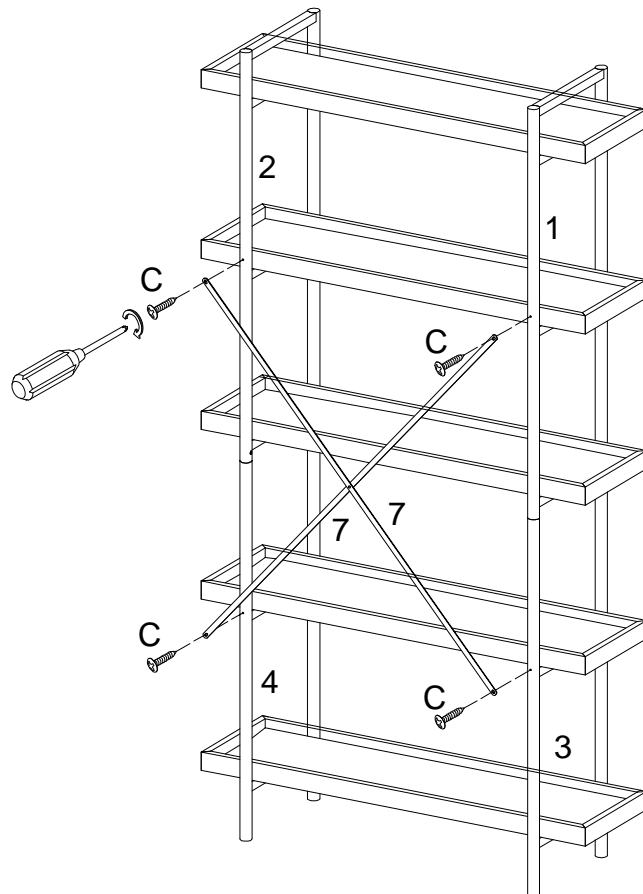

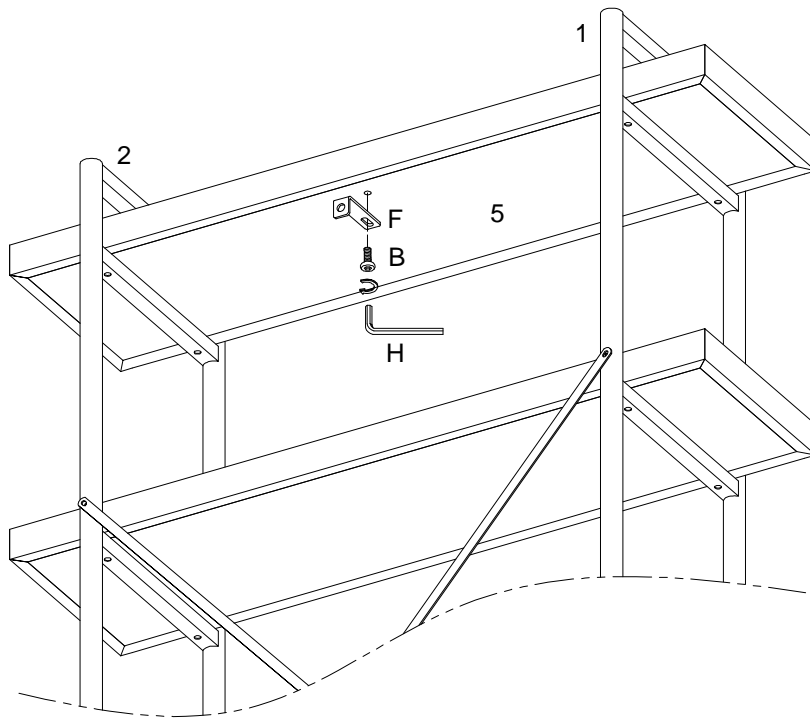
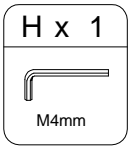
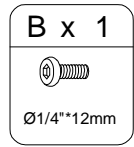
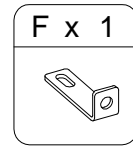

# Step 5

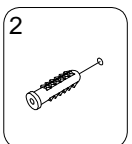
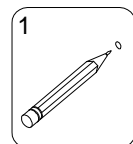
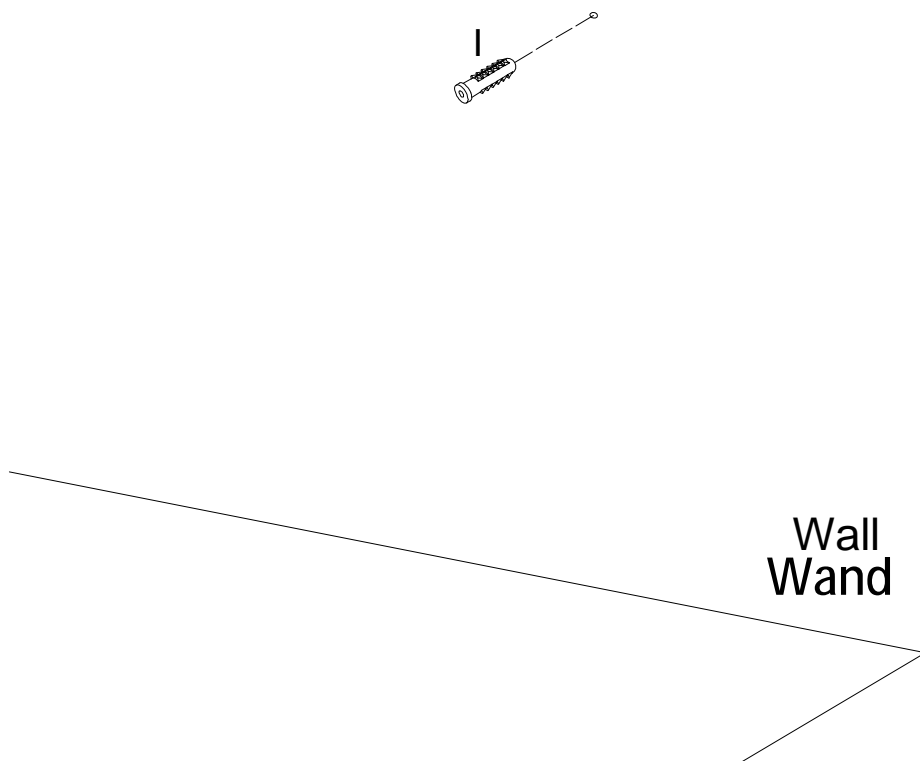
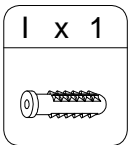

# Step 6



# Step 7

J x 1	K x 1
	
Ø4*30mm	Ø16*6.5*1.0mm

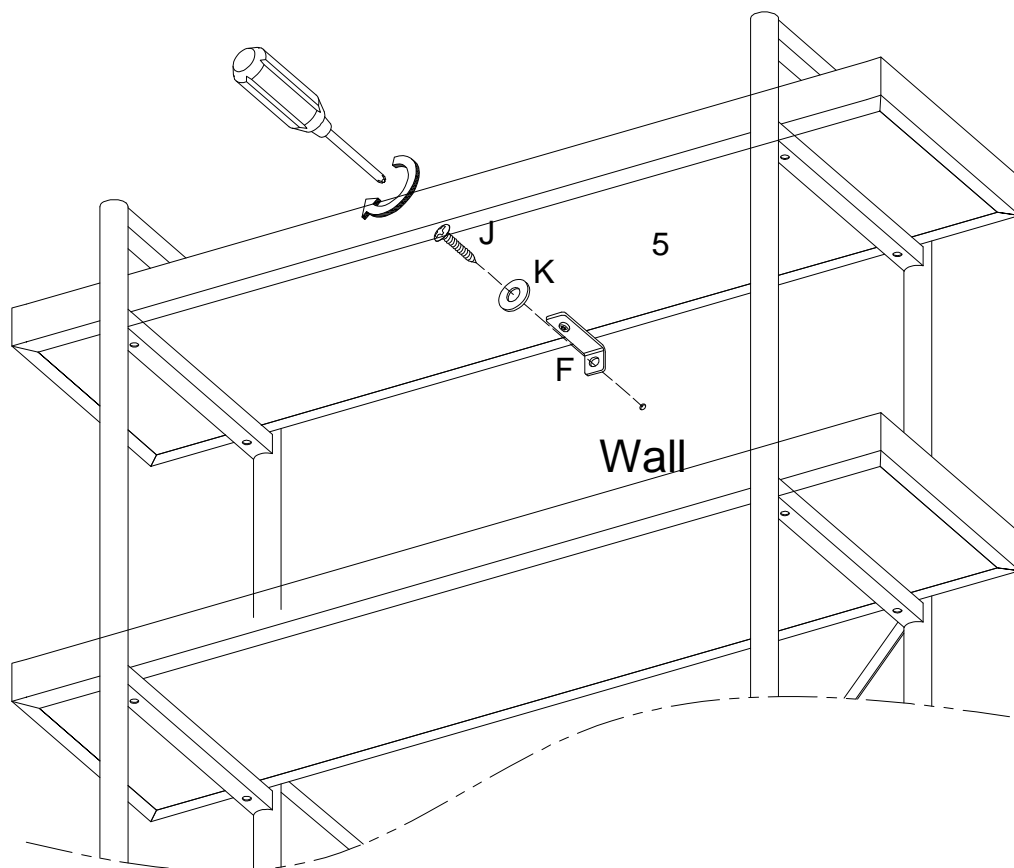

# Step 8

